

data sheet

Colenta[®]

WideTrackProcessor

200 RA 80 / 200 RA 125

5Tank Stabilizer



Colenta[®]

Colenta DIGITAL Processor - Available for RA4 Print /
Display Film for both digital and conventional applications. 02/2004 AN



WideTrack Processor

200 RA 80 and 200 RA 125

5 Tank Stabilizer

Technical Specifications:

Processing applications: RA4 Print / Display Film for both digital and conventional applications.

Process width: 200 RA 80...max. 200 cm (80 inch)
200 RA 125...max. 200 cm (80 inch)

Microprocessor Control: - with 2 pre-programmable processing cycles

Transport Speed (at 45 sec DEV-Time): - 200 RA 80 cm/min (32 inch/min)
(Dev time is pre-programmable) - 200 RA 125 cm/min (49 inch/min)

<i>Tank capacities:</i>	200 RA 80	200 RA 125
Developer :	46 lt	70 lt
Bleachfix :	46 lt	70 lt
Stabilizer1 :	46 lt	70 lt
Stabilizer2 :	46 lt	70 lt
Stabilizer3 :	46 lt	70 lt

All Colenta Wide Track models are micro processor controlled and provide a fully automatic Dry to Dry service for both cut sheet and long roll through a well proven minimum contact hard roller transport system.

Dual programme facilities provide a fast change between RC Print and Film production modes and allow complete flexibility for programming parameters to meet precise process requirements.

Replenishment: - precisely controlled using opto-sensors to measure the area loading.
- activated after a pre-set print/film area is fed into the processor

High efficiency drying: An integrated flat path warm air drying system with airknives

Temperatures: All solution temperatures are accurately controlled and monitored with automatic cooling.

Transport: Drive motor: precisely controlled by electronic feed-back to ensure consistent developer timing

Standard Accessories:-

- # Motorised Roll Take-Up # Rack Carrier/Drip Tray
- # Replenishment storage tanks # water supply / drain connectors.

Optional Accessories:

- # Inbuild Long Roll feed unit to include light tight feed box covers, long roll feed cradle with spool bobbins
- # Chemistry mixer 60 litres # Chemistry mixer 100 litres
- # Colenta IMC Isolation Mixing and Storage console 60 litres or 120 litres

Technical specification subject to change without notice.

Transport system:

Colenta®

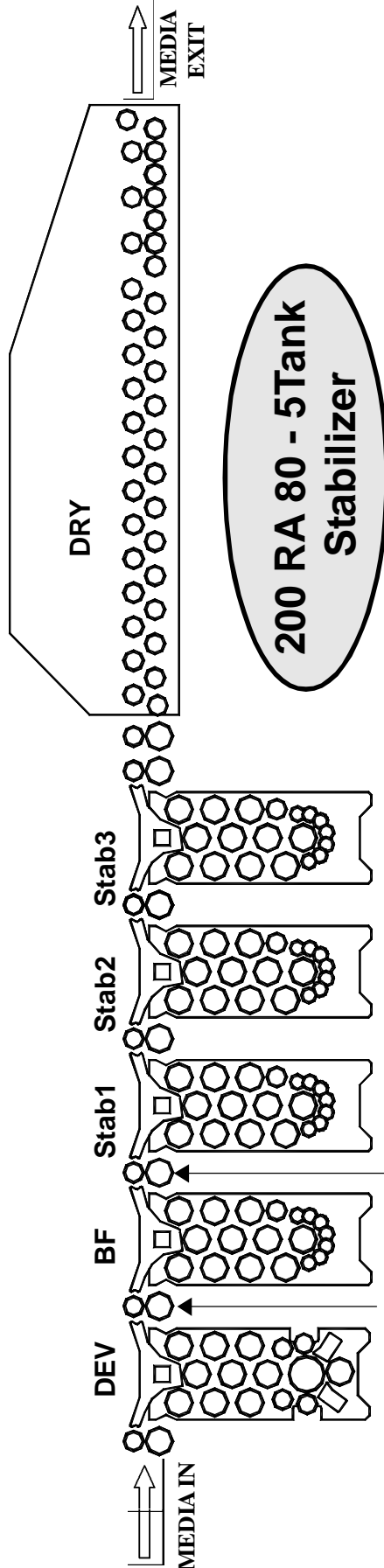

Rinsed Cross Over rollers

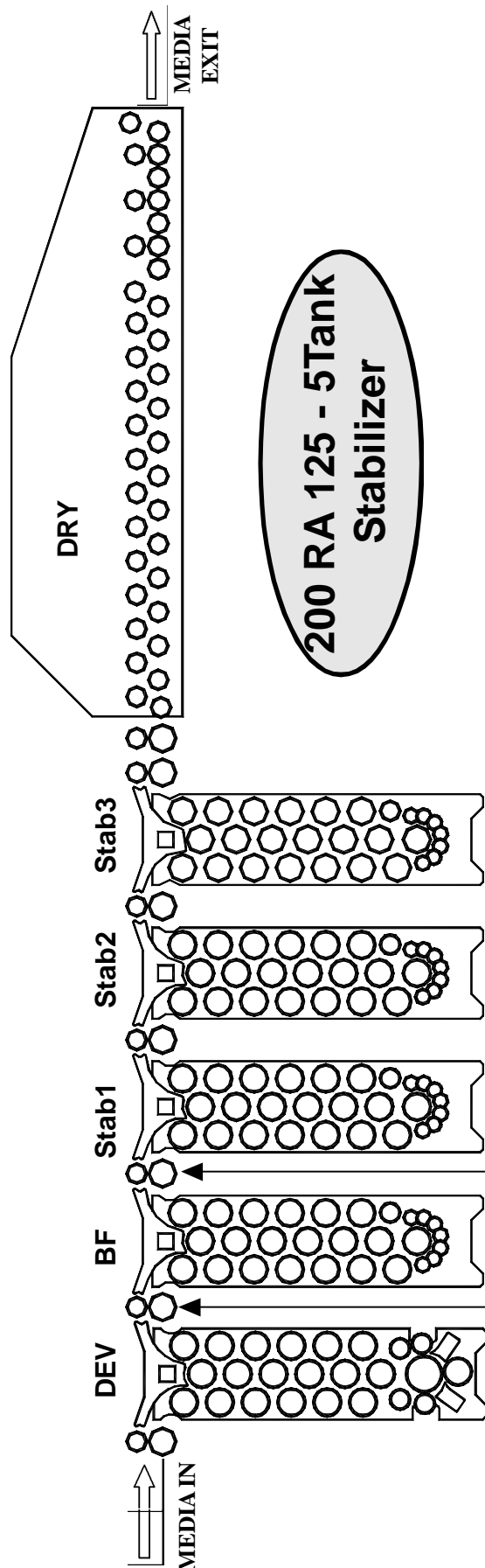

Rinsed Cross Over rollers

DIMENSIONS:

200 RA 80 / 125 5Tank STABILIZER

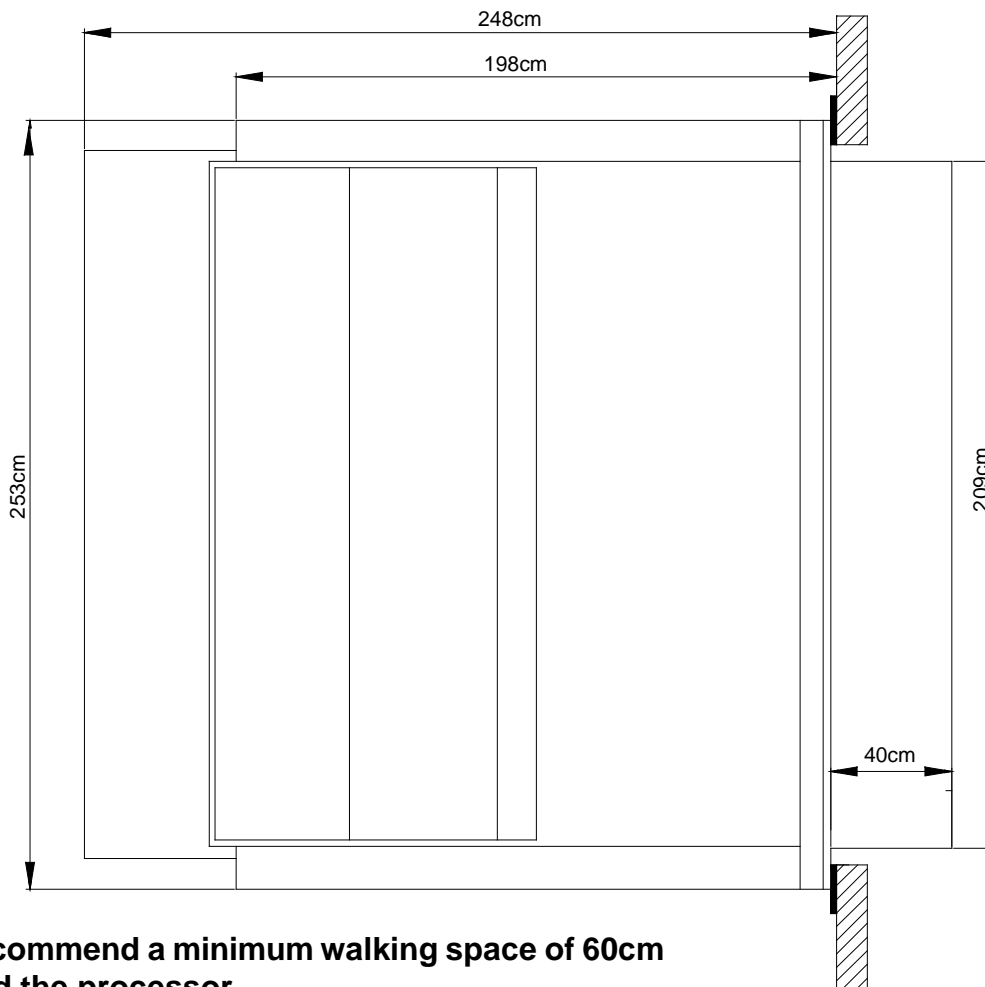
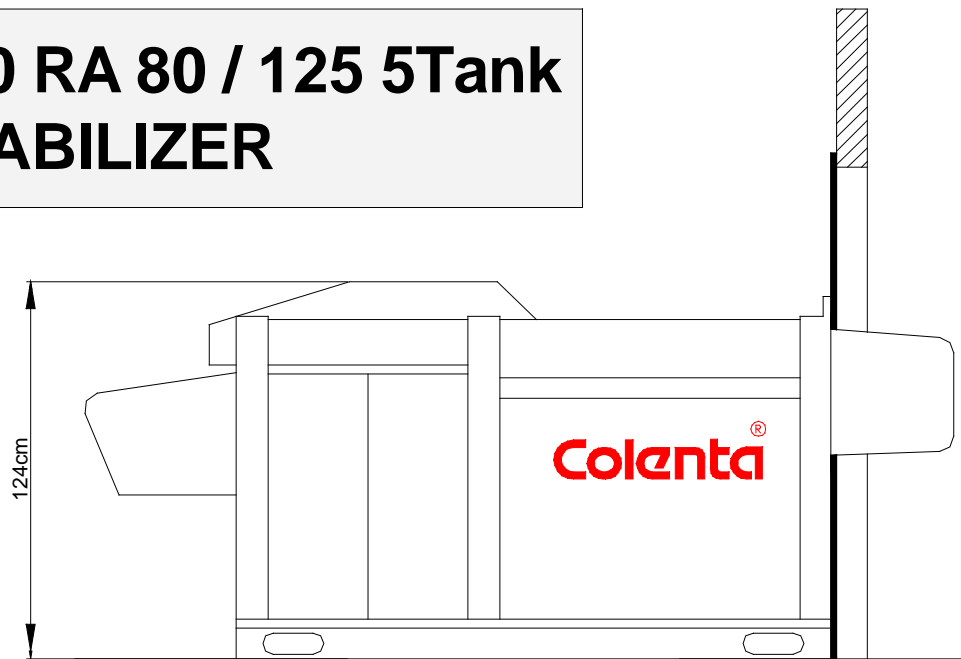

We recommend a minimum walking space of 60cm around the processor.

Specifications for wall-opening when the processor has to be installed that way.

200 RA 80 5Tank Stabilizer
200 RA 125 5Tank Stabilizer

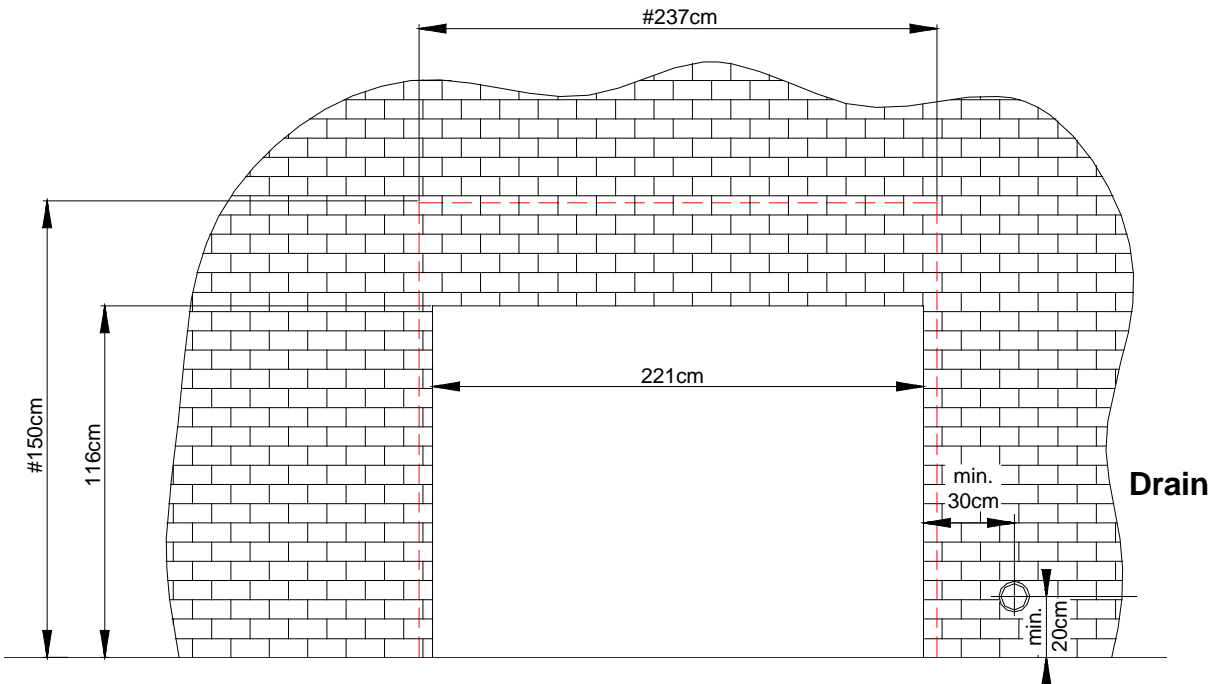

In case the thickness of the wall is more than 2cm, the cut-out of the wall has to be made according to the measurements marked with # - in that case a panel has to be installed as well, this to keep the cover lid of the processor in position - as shown below:

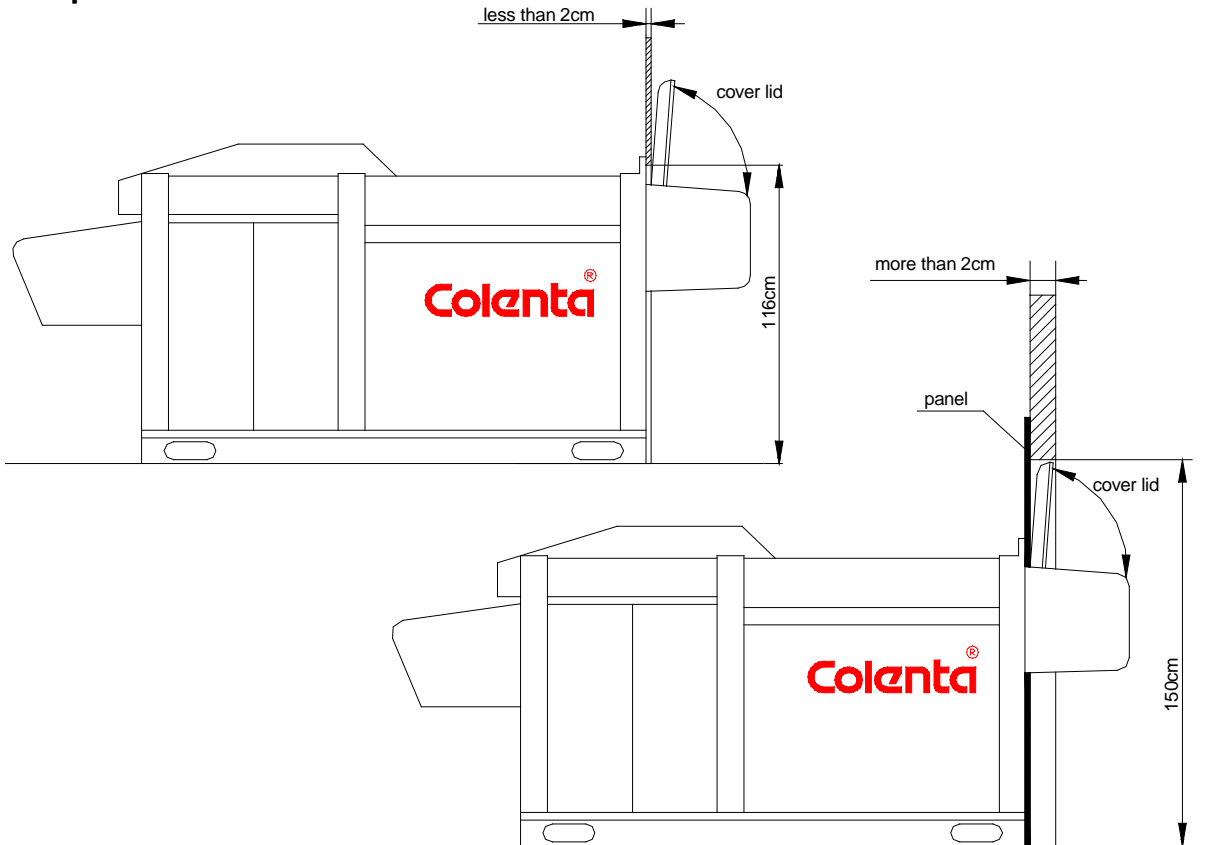

Electrical supply: Standard, when 3N~400/230V, 50/60 Hz supply available

Total power consumption:	
200 RA 95 5T	17 kW
200 RA 125 5T	17 kW

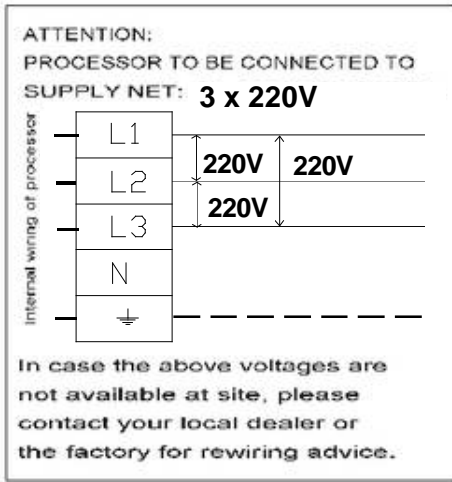
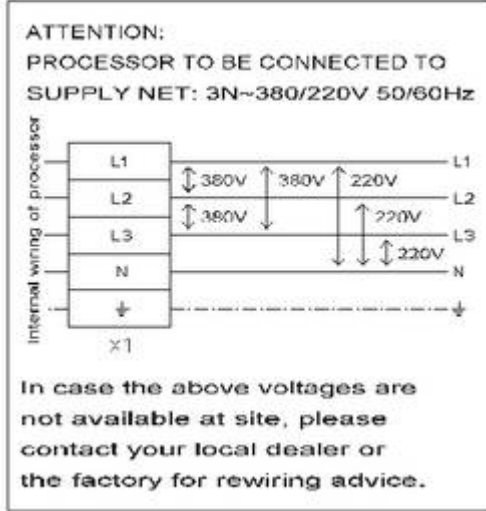

Alternative, the processor can be installed using 3x220V 50/60 Hz supply net - this has to be indicated accordingly when ordering.

Details for shipment:

200 RA 80 5Tank Stabilizer

200 RA 125 5Tank Stabilizer

Tankbody
1 wooden box on palette
263cm x 178cm x 136cm (L x W x H)
weight with packing: 825 kg

Dryer section
1 wooden box on palette
263cm x 123cm x 136cm (L x W x H)
weight with packing: 427 kg

Racks and dryer
1 wooden box on palette
228cm x 120cm x 107cm (L x W x H)
weight with packing: 707 kg