

data sheet

COLENTA ONLINE SYSTEM IL 80/110 DD/OL for Heidelberg Primesetter 74/102

Automatic Twin-Processor
Automatic Twin-Processor

DOUBLE DECKER DD

FILM & PLATE



Colenta[®]

for Graphic Art Films and PE-Printing Plates (up to 0,3 mm)
PLATE - 125 cm/min at 20 sec dev time
FILM - 175 cm/min at 20 sec dev time

Colenta Imageline®

DD-model processors have 9 programmable processing channels (9 for FILM & 9 for PLATE), an intermediate rinse bath rack system, covered stand, hose/tube connection (100 mm dia.) facility for ventilation of the processors wet-section to an external exhaust fan and supplied with 4 x 30 lt replenishment storage tanks

With level control in both, DEV/FIX and ACT/STAB processor tanks to automatically “top-up” chemistry when levels are low.

With level control in wash tanks: high/low level monitoring with alarm warning.

With automatic wash tank “fill” when processor is switched on.



Technical Specifications

Processing applications FILM :	Films, RC-paper, Rolls/Cut sheets of all commonly used film/paper inclusive of I.R.Material
Processing applications PLATE :	All commonly used PE-Printing PLATES
Film thickness:	up to 0,18mm (7mil)
Plate thickness:	up to 0.3mm
Material width:	min. 7,5 cm max. 80/110cm
Time in DEVELOPER:	min. 20 sec - max. 100 sec
Time in ACTIVATOR:	min. 17 sec - max. 100 sec
Input speed.	PLATE : 20sec/DEV-Time 125cm/min FILM : 20sec/DEV-Time 175cm/min

Tank capacity -	Developer	IL DD 80	IL DD 110
	Fixer:	19L	23L
	Wash water:	19L	23L
FILM		17L	21L

Tank capacity -	Activator	IL DD 80	IL DD 110
	Stabilizer	15L	20L
	Wash water:	15L	20L
PLATE		12.5L	17.5L

Solution heating(Fix and DEV):	adjustable in a range of 18°C - 43°C (separate inline 550W heaters)
Solution heating(Activator):	adjustable in a range of 18°C - 43°C (separate inline 350W heaters for DD 56 - 95) (separate inline 550W heaters for DD 110)

Dryer Film :	warm air variable in a range of 18°C - 50°C
---------------------	--

Dryer Plate :	warm air variable in a range of 18°C - 50°C
----------------------	--

Replenishment Film & Plate :	fully automatic. replenishment is microprocessor controlled and calculated from information received from sensors measuring the width and length of material entering the processor. Replenishment cycles are adjustable.
---	--

Wash water distribution:	FILM & PLATE : built in 4-way magnetic valve
Wash water flow rate:	2 ltr/min when film/plate is processed
Wash water supply pressure:	3 - 10 bar for FILM&PLATE
Wash water supply temp.:	filtered at a temperature of 8°C - 15°C with 3/4" hose connection
Wash water drain:	32mm (5/4inch) hose or tube

<u>Weight:</u>	Empty	IL DD 80	IL DD 110
	With solution	485 kg	547 kg
		585 kg	668 kg

Technical specification subject to change without notice.

GLOSSARY

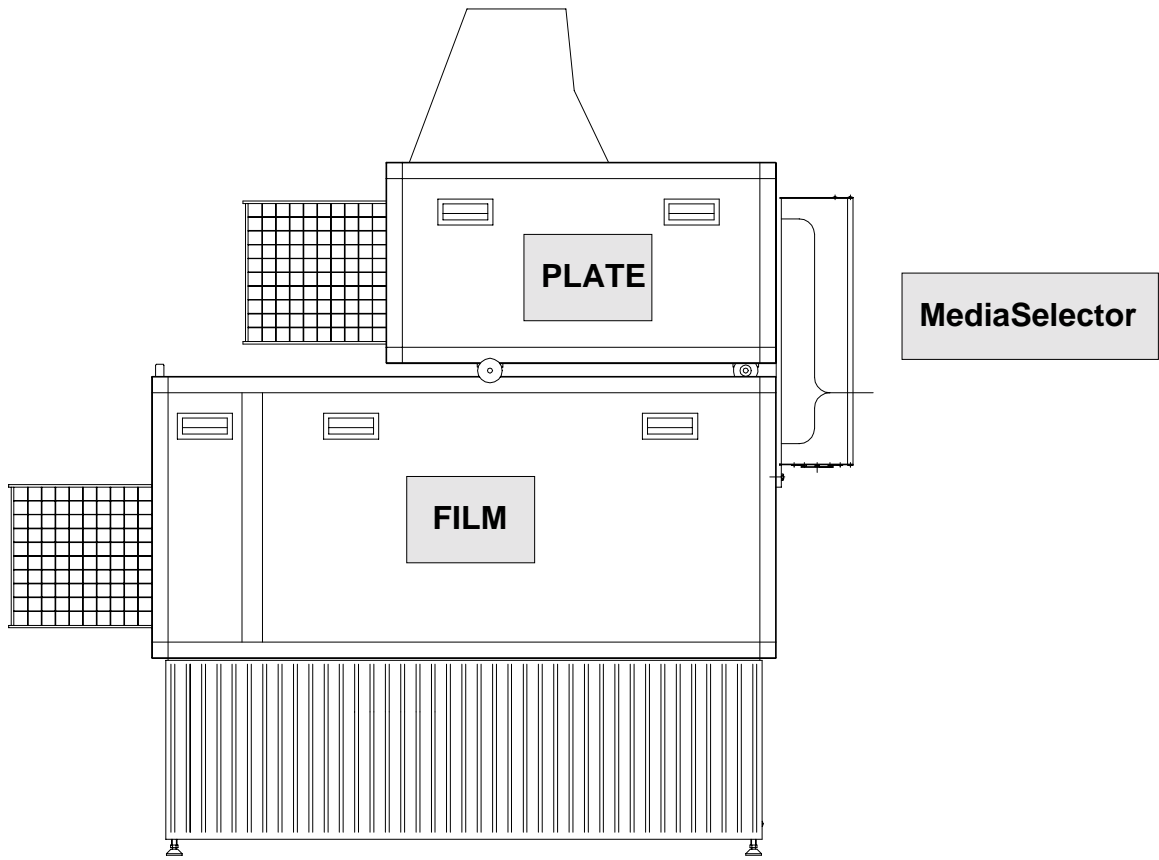
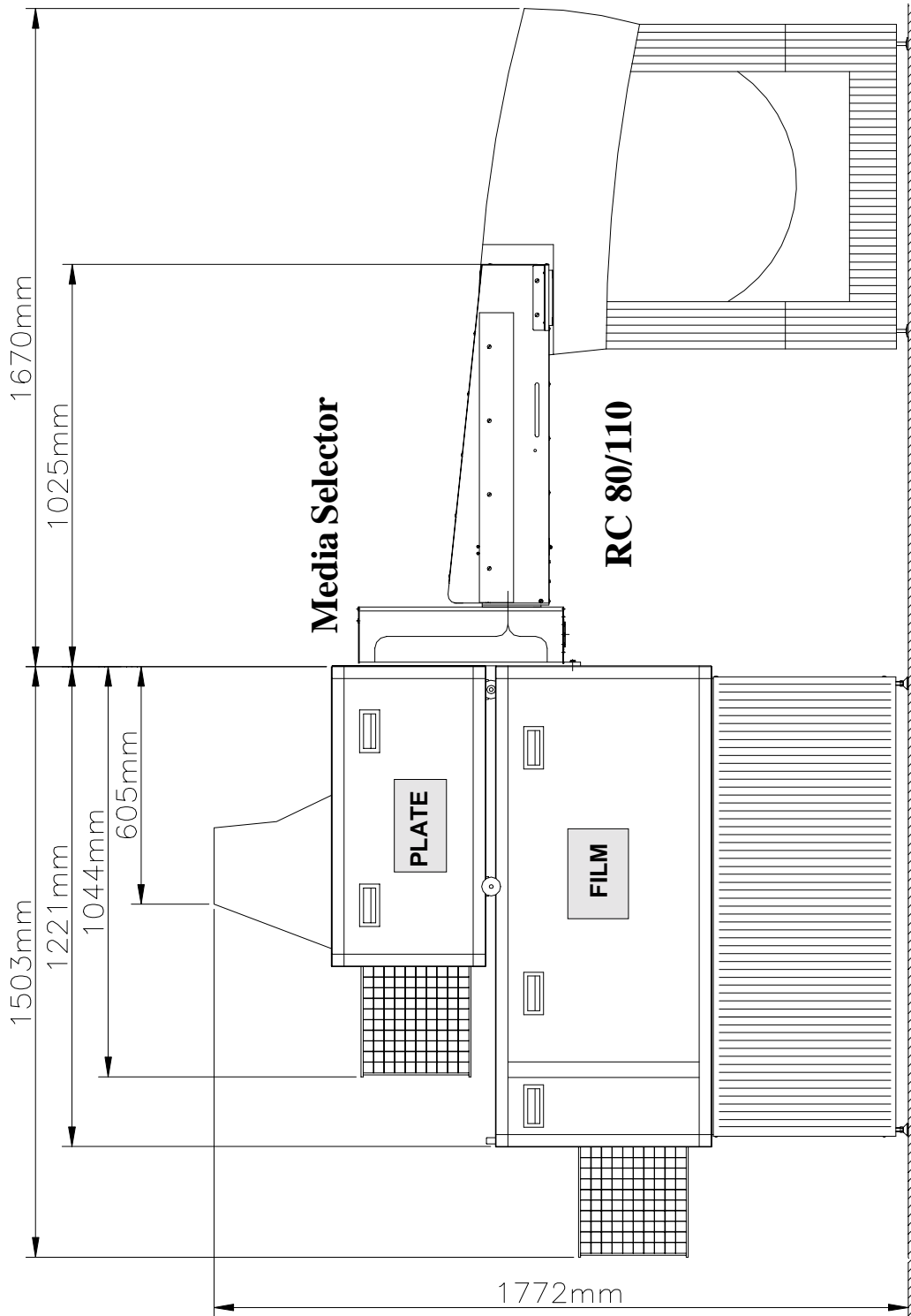

PLATE	80 PL-DD 110 PL-DD	DD- 80 OL DD-110 OL
FILM	80 SP-DD 110 SP-DD	
MediaSelector	80 MS-DD 110 MS-DD	

DIMENSIONS OF:

IL 80/110 DD/OL



**Primesetter
74/102**

Processor IL 80 & 110 DD-OL

DIMENSIONS OF:

IL 80/110 DD/OL

X.....for IL80 DD/OL 1100 mm
for IL110 DD/OL 1398 mm

Processor:

- IL DD 80 OL
- IL DD 110 OL

Y.....for Primesetter 74 1727mm
for Primesetter 110 2047mm

Primesetter 74/102

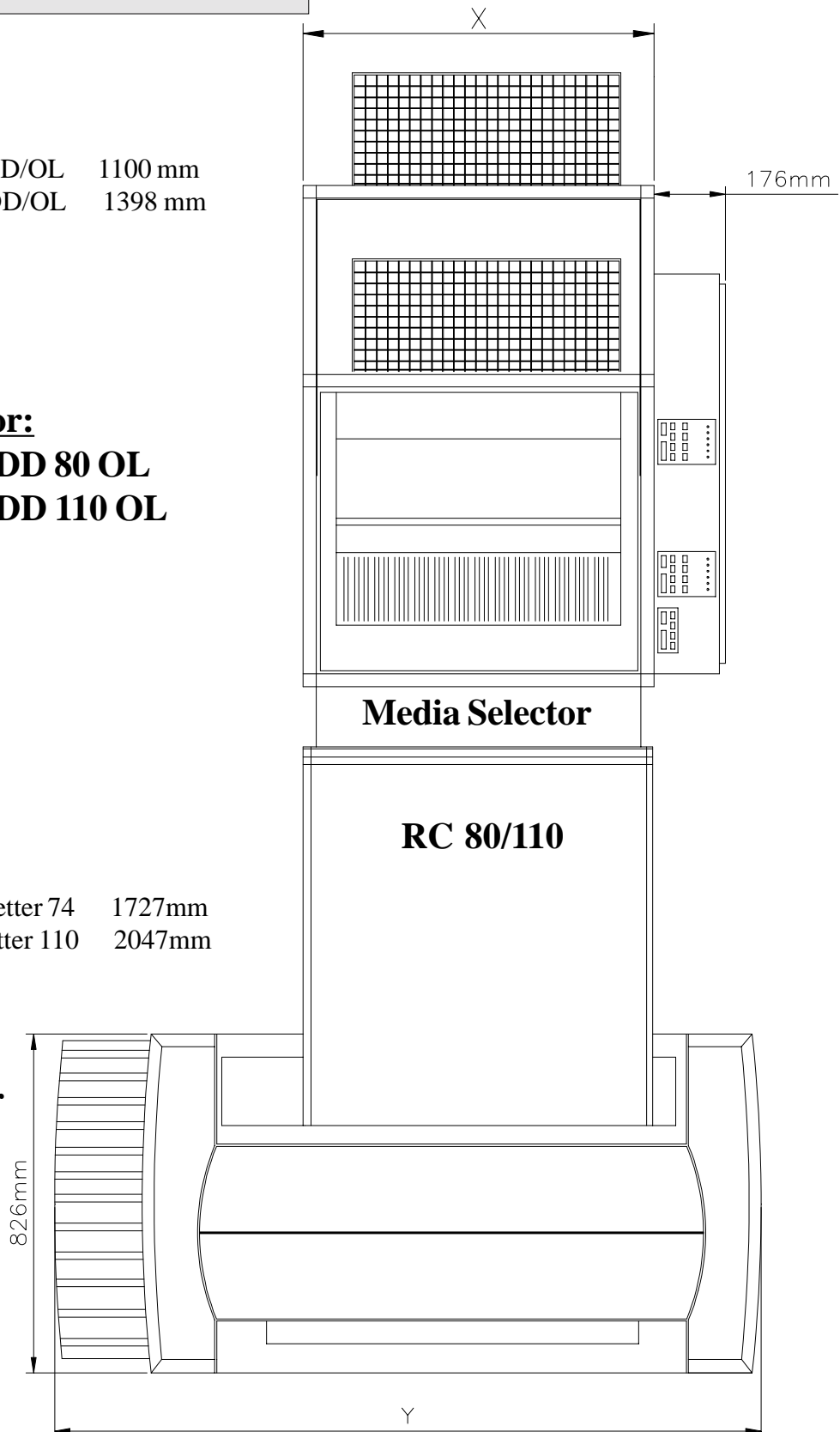

WORKING WITH THE MEDIA SELECTOR

MEDIA SWITCH

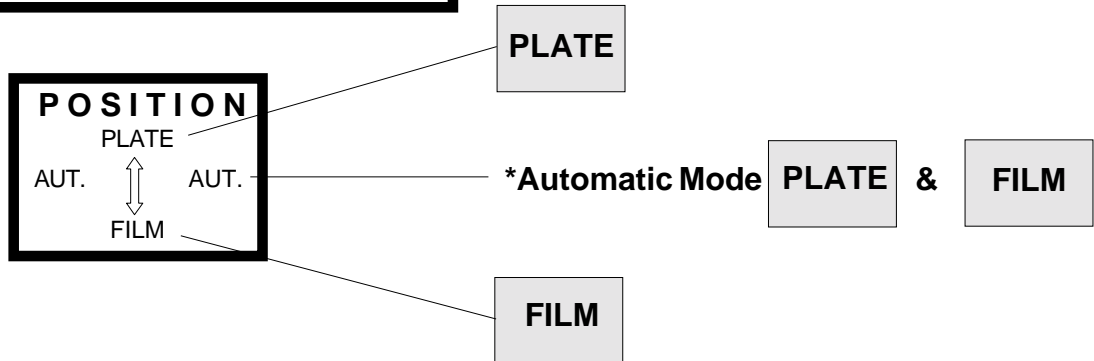

* To work with the Automatic Mode the Film and the Plate-processor must have reached working conditions and Typesetter must be able to supply the corresponding control signal to operate the MediaSelector

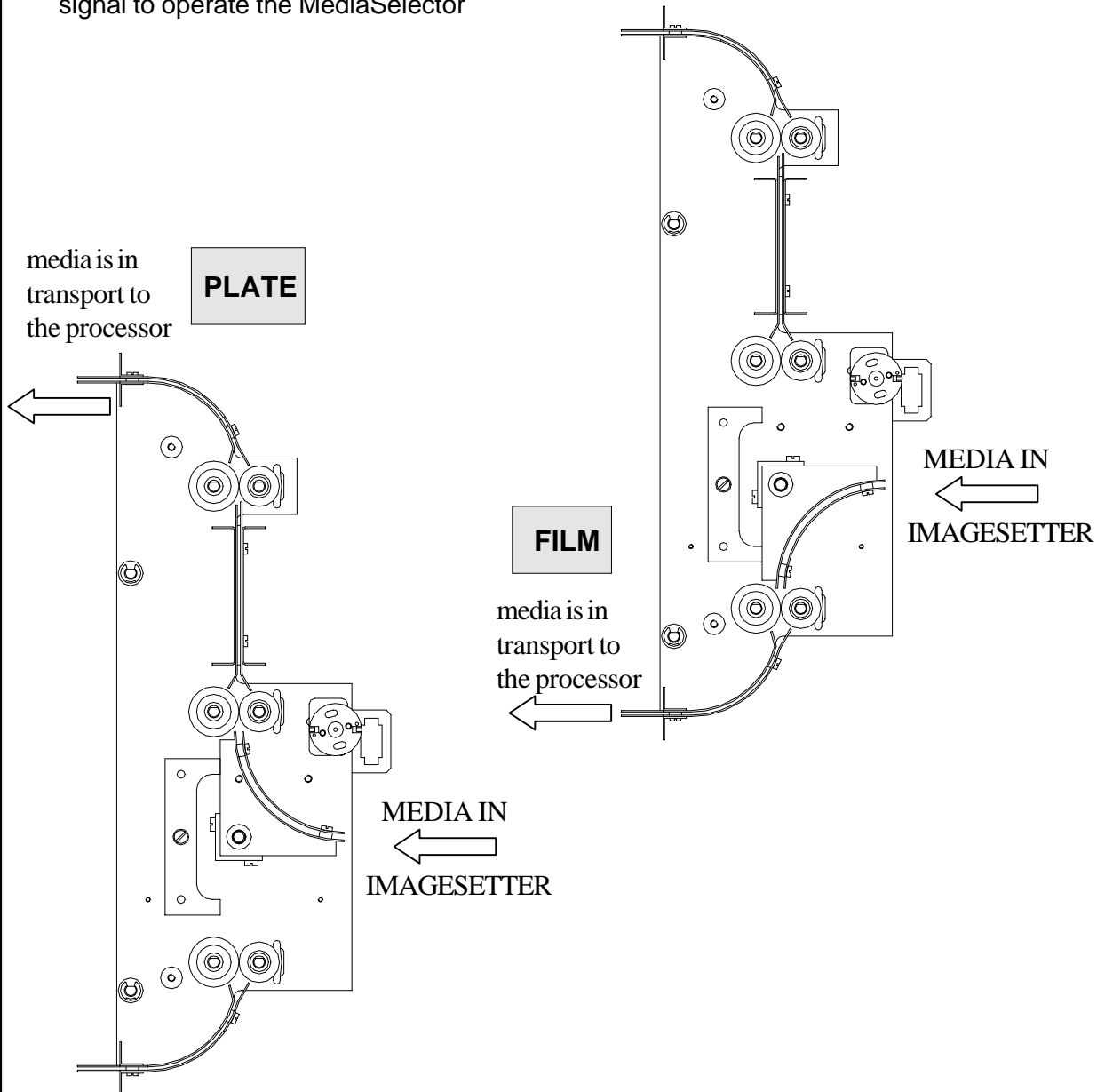

TRANSPORTSYSTEM:

Colenta[®]

FILM

IL 80/110 DD/OL

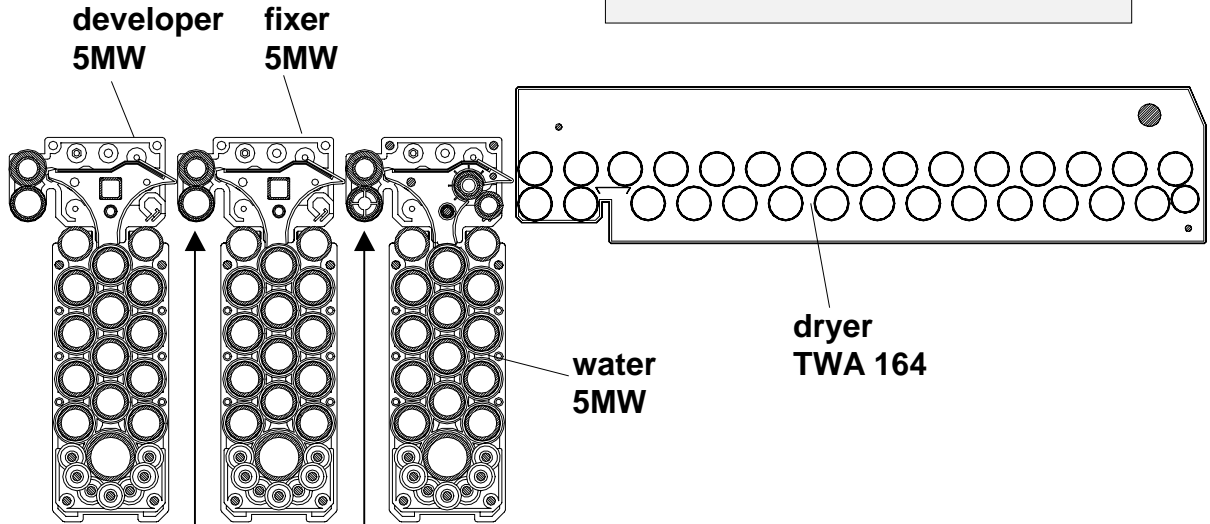

PLATE

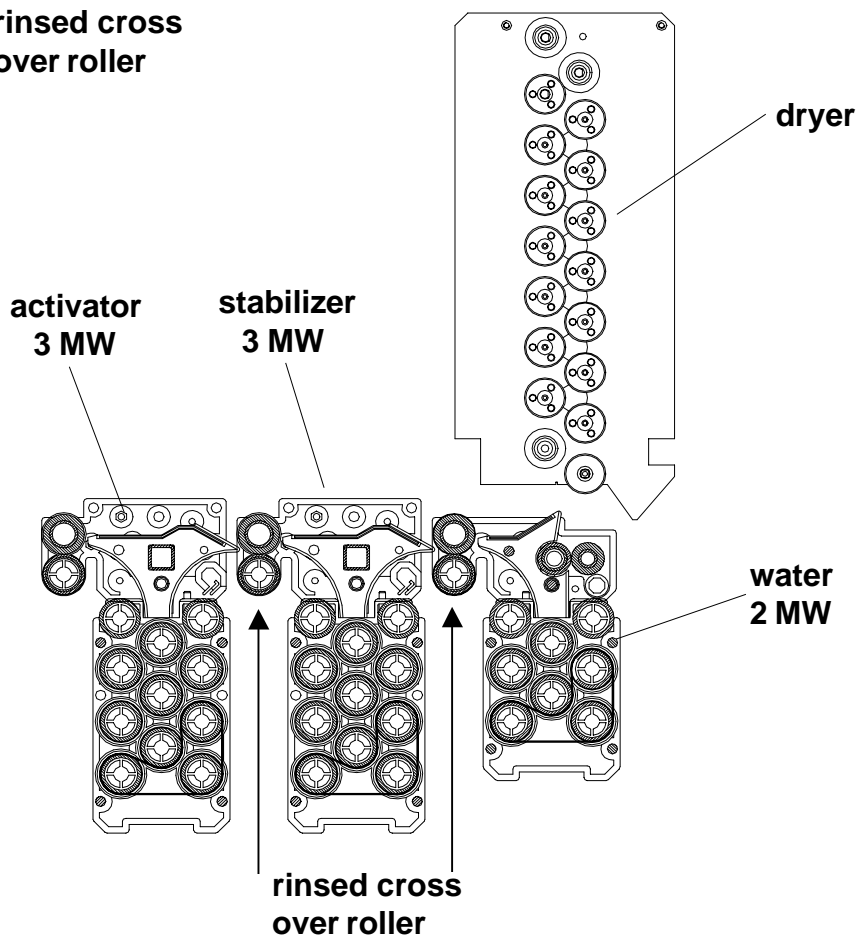

Electrical supply: (Standard, when 3N~400/230V, 50/60 Hz supply available)

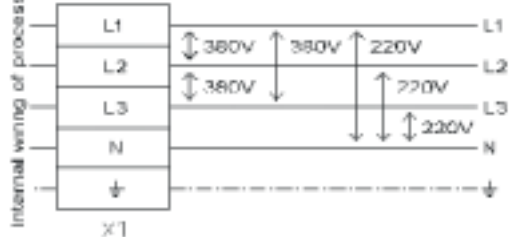
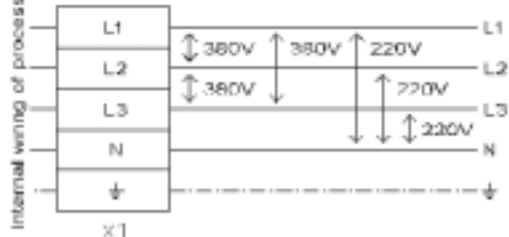
<p>FILM</p>	<p>3N~ 400/230V 50/60Hz</p>	<p>ATTENTION: PROCESSOR TO BE CONNECTED TO SUPPLY NET: 3N~380/220V 50/60Hz</p>  <p>In case the above voltages are not available at site, please contact your local dealer or the factory for rewiring advice.</p>
<p>DD 80</p>	<p>6,5 kW 13 A</p>	
<p>DD 110</p>	<p>11,5 kW 20 A</p>	
<p>PLATE</p>	<p>3N~ 400/230V 50/60Hz</p>	<p>ATTENTION: PROCESSOR TO BE CONNECTED TO SUPPLY NET: 3N~380/220V 50/60Hz</p>  <p>In case the above voltages are not available at site, please contact your local dealer or the factory for rewiring advice.</p>
<p>DD 80</p>	<p>4,0 kW 13 A</p>	
<p>DD 110</p>	<p>6,1 kW 13A</p>	
<p>MediaSelector</p>	<p>12V- DC (supplied by processor)</p>	

Electrical supply:

(alternatives, to be indicated when ordering)

DD 80 FILM	6,5 kW 13 A
DD 80 PLATE	6,5 kW 20 A

ATTENTION:
PROCESSOR TO BE CONNECTED TO
SUPPLY NET: 3 x 220V

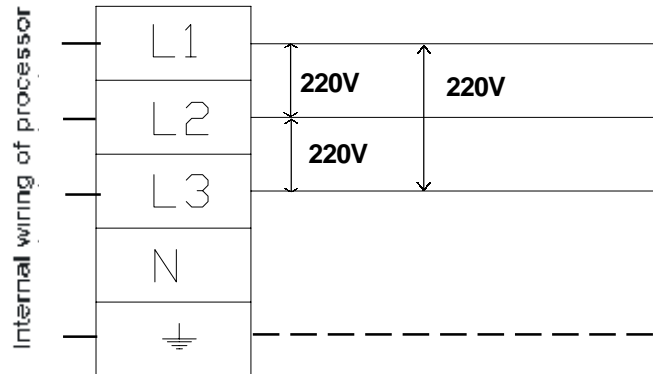

In case the above voltages are not available at site, please contact your local dealer or the factory for rewiring advice.

DD 80 FILM	N/A N/A
DD 110 PLATE	N/A N/A

ATTENTION:
PROCESSOR TO BE CONNECTED TO
SUPPLY NET: 220V 50/60Hz

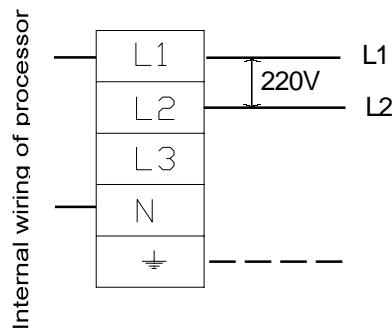

In case the above voltages are not available at site, please contact your local dealer or the factory for rewiring advice.

Details for shipment:

IL DD 80 OL : Heidelberg Primesetter 74

packing dimensions:	2 carton box on palette 170cm x 152cm x 160cm (L x W x H)
packing volume:	4,13 m ³
weight with packing:	490 kg
	180cm x 123cm x 145cm (L x W x H)
packing volume:	3,21 m ³
weight with packing:	300 kg

IL DD 110 OL : Heidelberg Primesetter 102

packing dimensions:	3 carton box on palette 170cm x 155cm x 130cm (L x W x H)
packing volume:	3,42 m ³
weight with packing:	320 kg
	180cm x 123cm x 148cm (L x W x H)
packing volume:	3,27 m ³
weight with packing:	290 kg
	180cm x 123cm x 148cm (L x W x H)
packing volume:	3,27 m ³
weight with packing:	360 kg