

data sheet

Colenta[®]

Colenta New Generation
140 RA4 Widetrack

WideTrackProcessor

140 RA4 95 5Tank WASH

140 RA4 125 5Tank WASH



Colenta[®]



Colenta DIGITAL Processor - Available for RA4 Print / Duratrans for both digital and conventional applications.

11/2019 AN

Colenta[®] WideTrack Processor

140 RA4 95/125 5Tank WASH

Technical Specifications:

Processing applications: RA4 Print / Duratrans for both digital and conventional applications.

Process width: **140 RA4 95**...max. 140 cm (55 inch)
140 RA4 125...max. 140 cm (55 inch)

Microprocessor Control: with 9 pre-programmable processing cycles

Transport Speed (at 45 sec DEV-Time): for **140 RA4 95 5T**....95 cm/min (38 inch/min)
 (Dev time is pre-programmable) for **140 RA4 125 5T**....125 cm/min (49 inch/min)

Tank capacities:	140 RA4 95 5T	140 RA4 125 5T
Developer :	47 L incl. outside filters	55 L incl. outside filters
Bleachfix :	37 L incl. outside filters	45 L incl. outside filters
Wash1 :	35 L (circulated)	43 L (circulated)
Wash2 :	35 L (circulated)	43 L (circulated)
Wash3 :	35 L (circulated)	43 L (circulated)

All Colenta Wide Track models are micro processor controlled and provide a fully automatic Dry to Dry service for both cut sheet and long roll through a well proven minimum contact hard roller transport system.

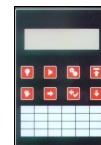

Dual programme facilities provide a fast change between RC Print and Film production modes and allow complete flexibility for programming parameters to meet precise process requirements.

Replenishment: - precisely controlled using opto-sensors to measure the area loading.
 - activated after a pre-set print/film area is fed into the processor

High efficiency drying: An integrated flat path warm air drying system with airknives

Temperatures: All solution temperatures are accurately controlled and monitored with automatic cooling.

Transport/ Drive motor: precisely controlled by electronic feed-back to ensure constant developer timing

Standard Accessories:-

- | | | |
|--|-----------------------------------|--------------|
| # Level control for all Processing tanks | # Rack Carrier/Drip Tray | # sleep mode |
| # Replenishment storage tanks | # water supply / drain connectors | |

Optional Accessories:

- # Inbuild Roll feed unit to include into the light tight feed box and long roll feed cradle with spool bobbins
- # Motorised Roll Take-Up # extra spool bobbins
- # water supply panel # 2 position chemical mixing concole (2x40L / 2x80L)

Technical specification subject to change without notice.

Transport system: 140 RA4 95 - 5Tank WASH

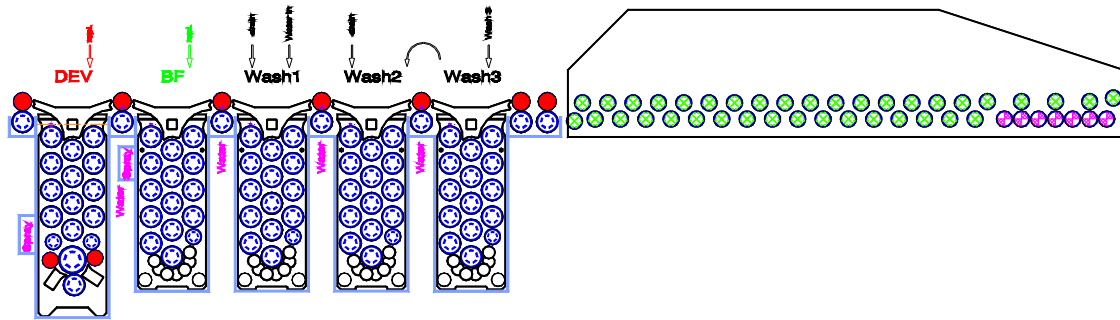

Transport system: 140 RA4 125 - 5Tank WASH

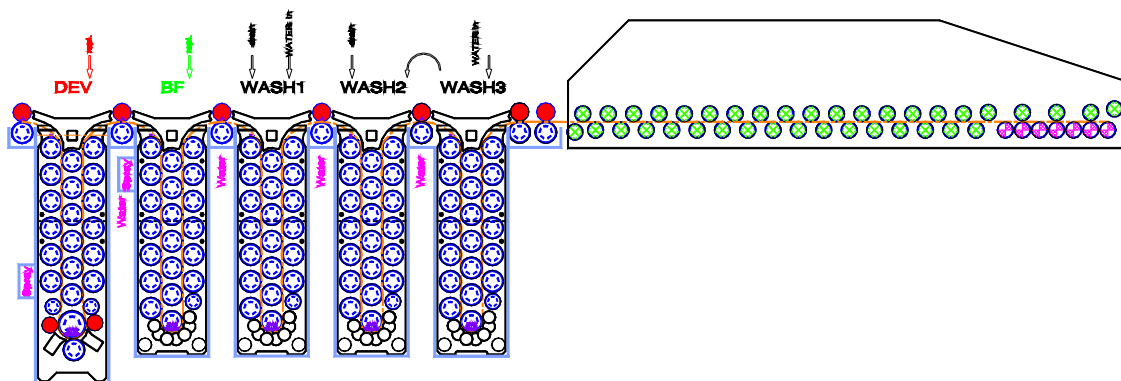

All transport modules (racks) and tanks are designed to reduce chemical oxidation to an absolute minimum. This together with our accurate replenishment, temperature control and constant circulation ensures all processing parameters are maintained within pre-set programmable limits.

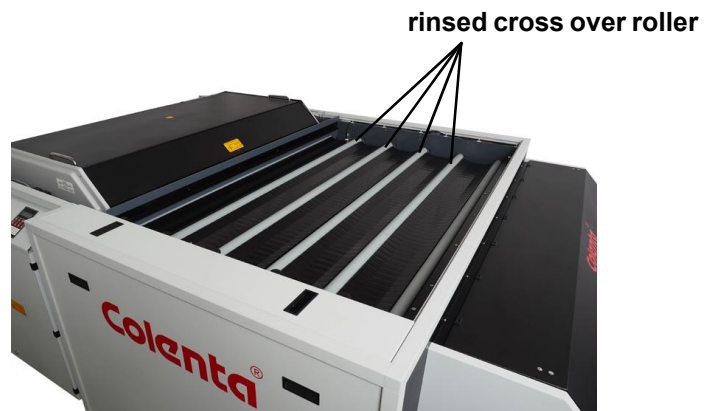
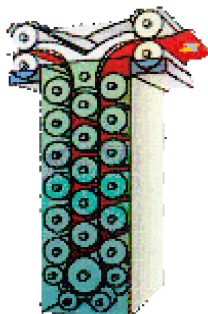

Water rinsed cross over rollers are in place in order to minimize the chemical carry over from one tank to the next as well to keep the cross over section clean and free from any chemical deposits.

DIMENSIONS:



140 RA 95 / 125 5Tank WASH

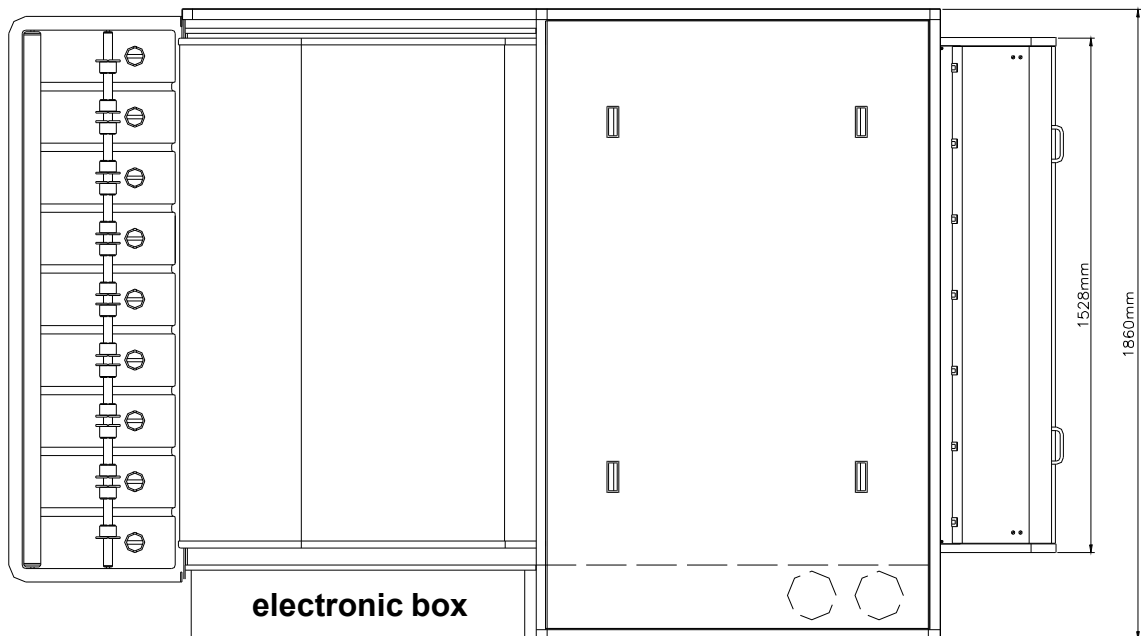
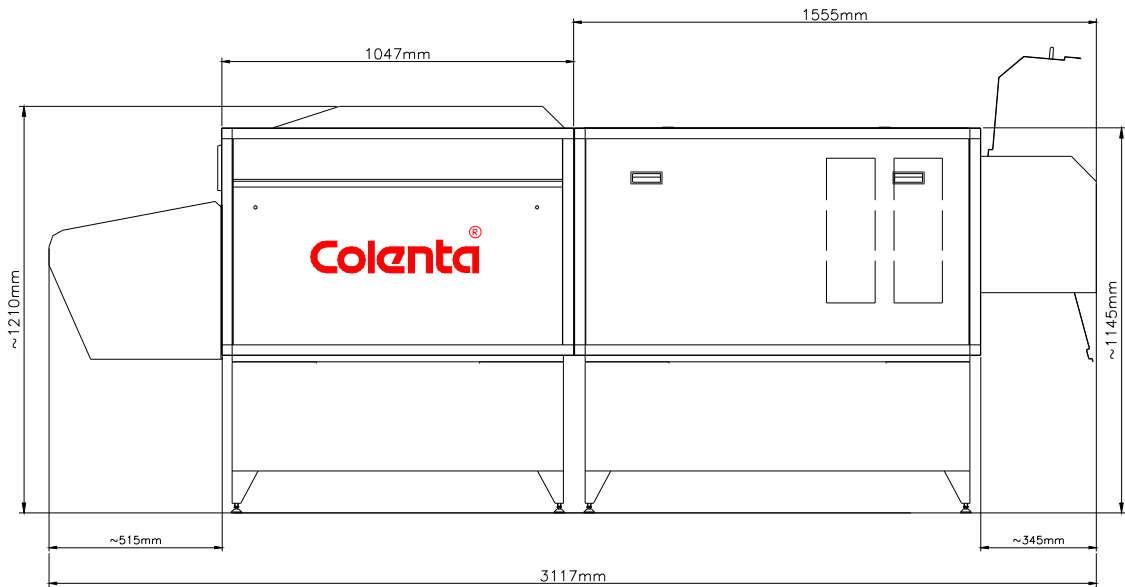

Outside filter housings for easy access

We recommend a minimum walking space of 60cm around the processor.

Specifications for wall-opening if the processor has to be installed that way:

140 RA 95 / 125 5Tank WASH

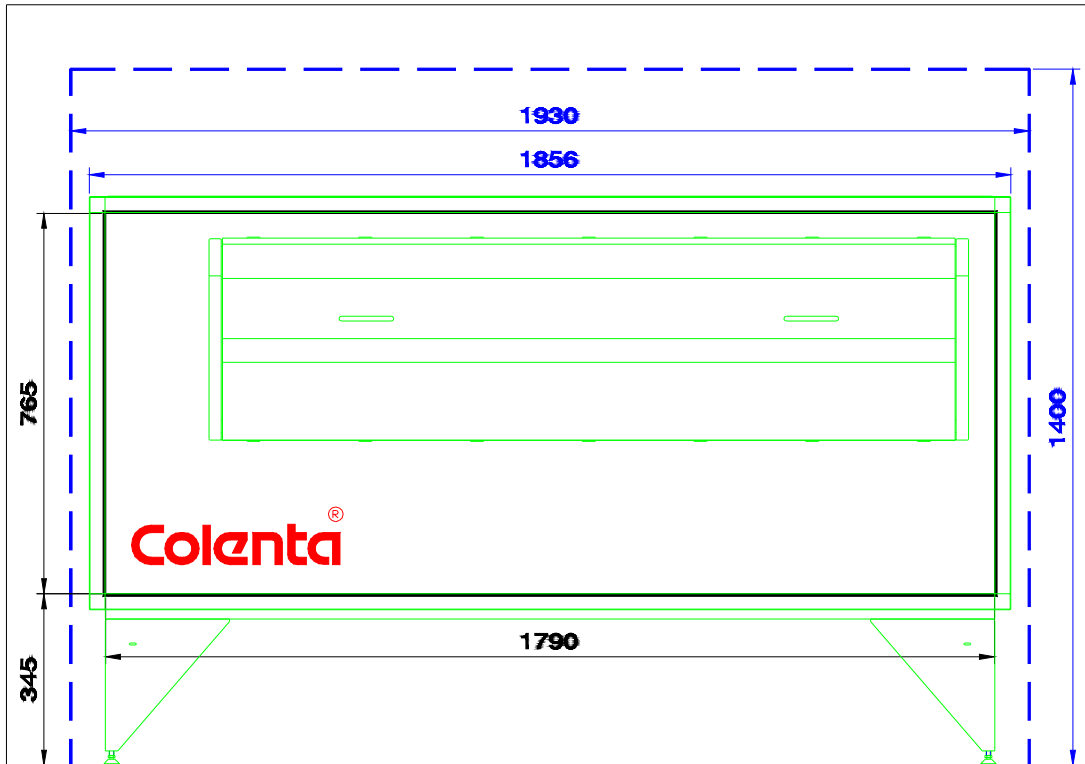

In case the thickness of the wall is more than 2cm, a panel has to be installed this to keep the cover lid of the processor in position - as shown below:

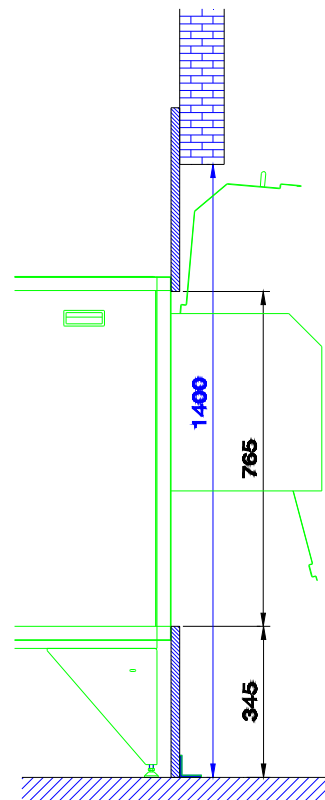

Electrical supply:



Standard, when 3N~400/230V,
50/60 Hz supply available

Total power consumption:	
140 RA4 95 5Tank WASH.....	14.5 kW
140 RA4 125 5Tank WASH.....	16.5 kW

Standard supply net:
3N-400/230 VAC 56/60Hz

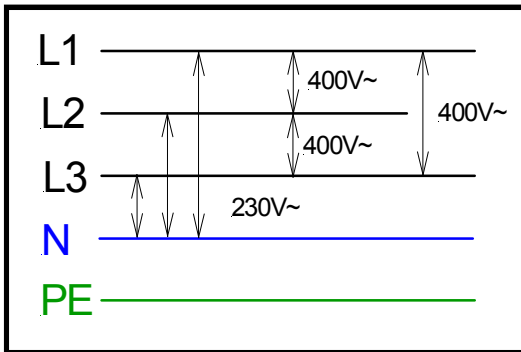

Alternatively:
3x230V 50/60 Hz

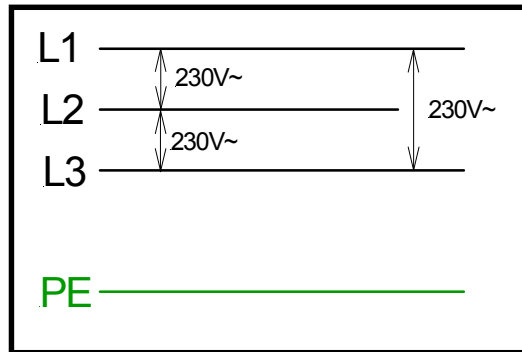

Single phase connections
(230VAC - 50/60Hz)
on request only.

To be indicated and confirmed
when ordering!



cabinet for power connection -
a suitable power cord is
provided with the processor

Details for shipment:



COLENTA 140 RA4 95
5Tank WASH

COLENTA 140 RA4 125
5Tank WASH

Collo 1: 200x120x140cm, 310 kg
Collo 2: 174x160x110cm, 600kg
Collo 3: 200x200x140cm, 620kg

Collo 1: 200x120x140cm, 310 kg
Collo 2: 174x160x110cm, 600kg
Collo 3: 200x200x140cm, 620kg

Colenta 140 RA4 95 / 125 5Tank WASH

Colenta® *Wide Track RA4 Paper Processor - optional accessories :*



Colenta®
Water Supply Panel assy
(see extra documentation)



Colenta®
2x40L / 2x80L Mixing Concole
(see extra documentation)



Colenta®
140 roll feed assy



Colenta®
140 motorized roll take up assy

water panel

processor

chemical
mixing concole

