

data sheet

Colenta[®]

Colenta New Generation
200 RA4 Widetrack

WideTrackProcessor

200 RA4 80 5Tank WASH

200 RA4 125 5Tank WASH



Colenta[®]



Colenta DIGITAL Processor - Available for RA4 Print / Duratrans for both digital and conventional applications.

11/2019 AN

Colenta[®] WideTrack Processor 200 RA4 80/125 5Tank WASH

Technical Specifications:

Processing applications: RA4 Print / Duratrans for both digital and conventional applications.

Process width: **200 RA4 80**...max. 200 cm (80 inch)
200 RA4 125...max. 200 cm (80 inch)

Microprocessor Control: with 9 pre-programmable processing cycles

Transport Speed (at 45 sec DEV-Time): for **200 RA4 80 5T**....80 cm/min (31 inch/min)
(Dev time is pre-programmable) for **200 RA4 125 5T**....125 cm/min (49 inch/min)

Tank capacities:	200 RA4 80 5T	200 RA4 125 5T
Developer :	53 L incl. outside filters	90 L incl. outside filters
Bleachfix :	44 L incl. outside filters	77 L incl. outside filters
Wash1 :	43 L (circulated)	75 L (circulated)
Wash2 :	43 L (circulated)	75 L (circulated)
Wash3 :	43 L (circulated)	75 L (circulated)

All Colenta Wide Track models are micro processor controlled and provide a fully automatic Dry to Dry service for both cut sheet and long roll through a well proven minimum contact hard roller transport system.



Dual programme facilities provide a fast change between RC Print and Film production modes and allow complete flexibility for programming parameters to meet precise process requirements.

Replenishment: - precisely controlled using opto-sensors to measure the area loading.
- activated after a pre-set print/film area is fed into the processor

High efficiency drying: An integrated flat path warm air drying system with airknives

Temperatures: All solution temperatures are accurately controlled and monitored with automatic cooling.

Transport/ Drive motor: precisely controlled by electronic feed-back to ensure constant developer timing

Standard Accessories:-

- # Level control for all Processing tanks
- # Rack Carrier/Drip Tray
- # sleep mode
- # Replenishment storage tanks
- # water supply / drain connectors

Optional Accessories:

- # Inbuild Roll feed unit to include into the light tight feed box and long roll feed cradle with spool bobbins
- # Motorised Roll Take-Up
- # extra spool bobbins
- # water supply panel
- # 2 position chemical mixing concole (2x40L / 2x80L)

Technical specification subject to change without notice.

Transport system: 200 RA4 80 - 5Tank WASH

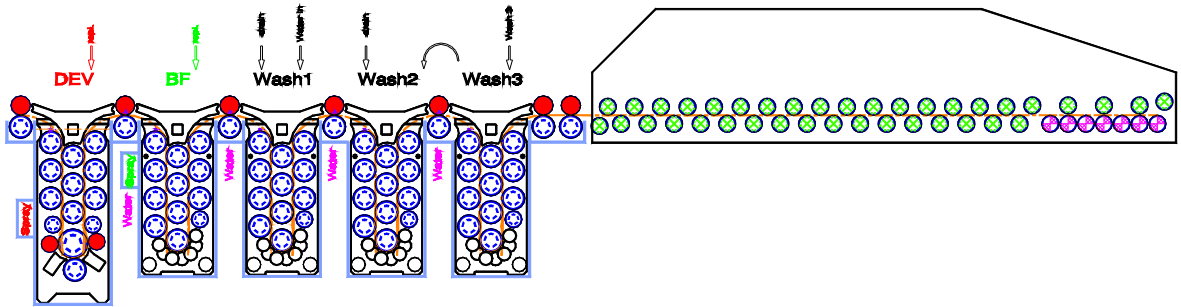

Transport system: 200 RA4 125 - 5Tank WASH

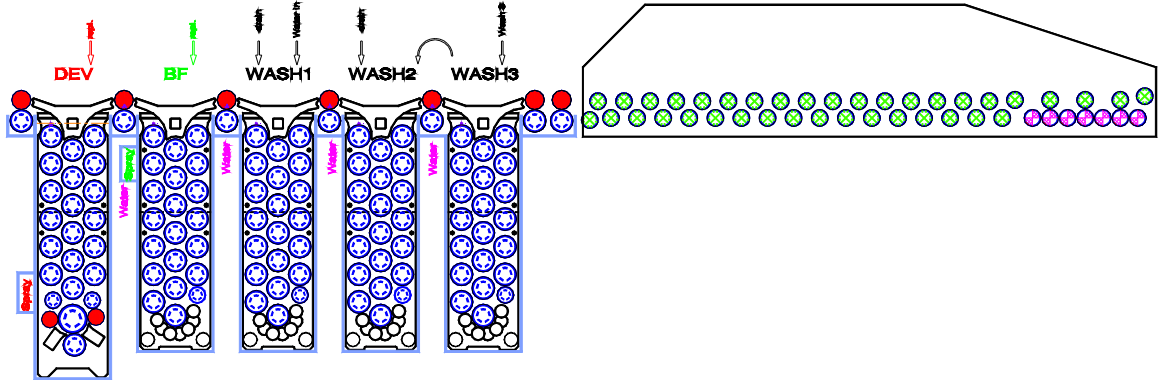

All transport modules (racks) and tanks are designed to reduce chemical oxidation to an absolute minimum. This together with our accurate replenishment, temperature control and constant circulation ensures all processing parameters are maintained within pre-set programmable limits.

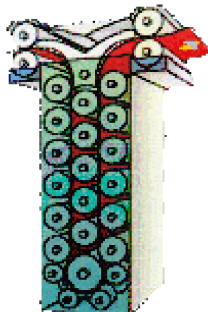

rinsed cross over roller



Water rinsed cross over rollers are in place in order to minimize the chemical carry over from one tank to the next as well to keep the cross over section clean and free from any chemical deposits.

DIMENSIONS:



200 RA 80 / 125 5Tank WASH

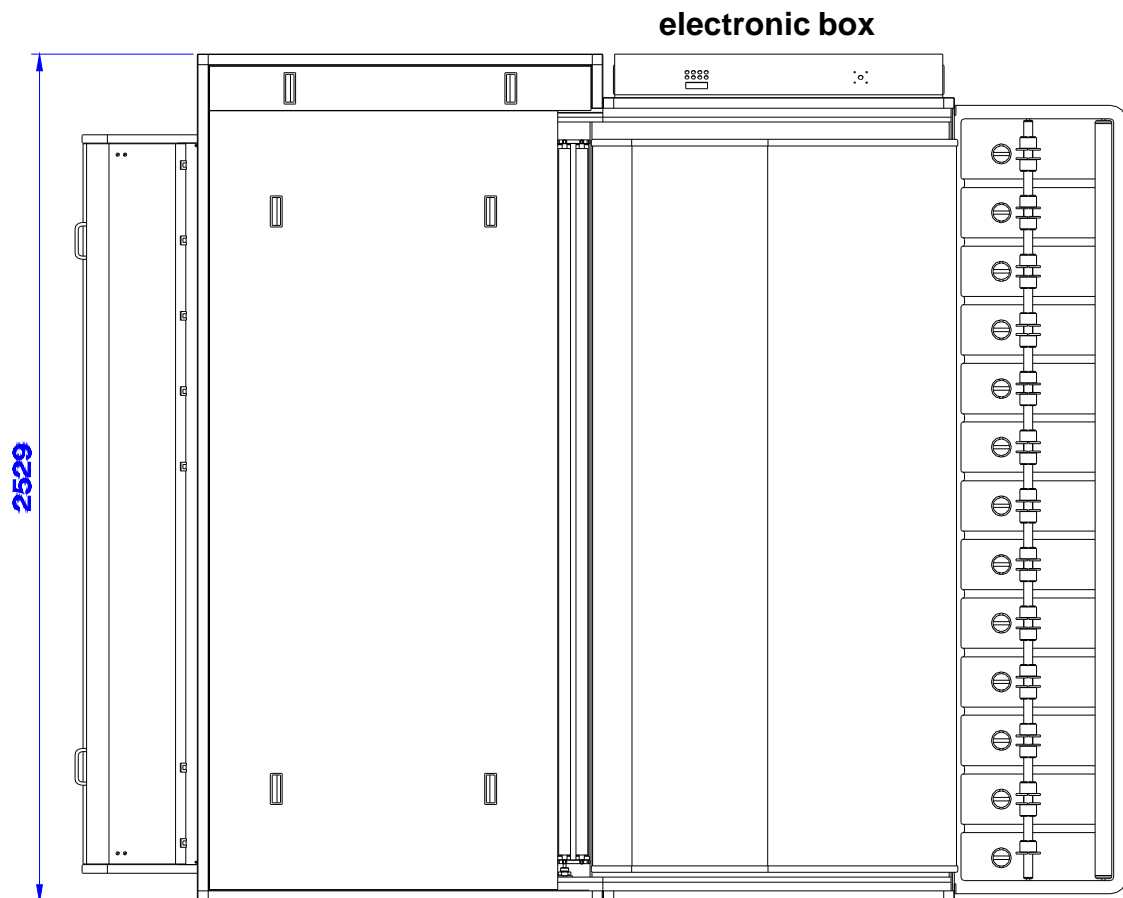
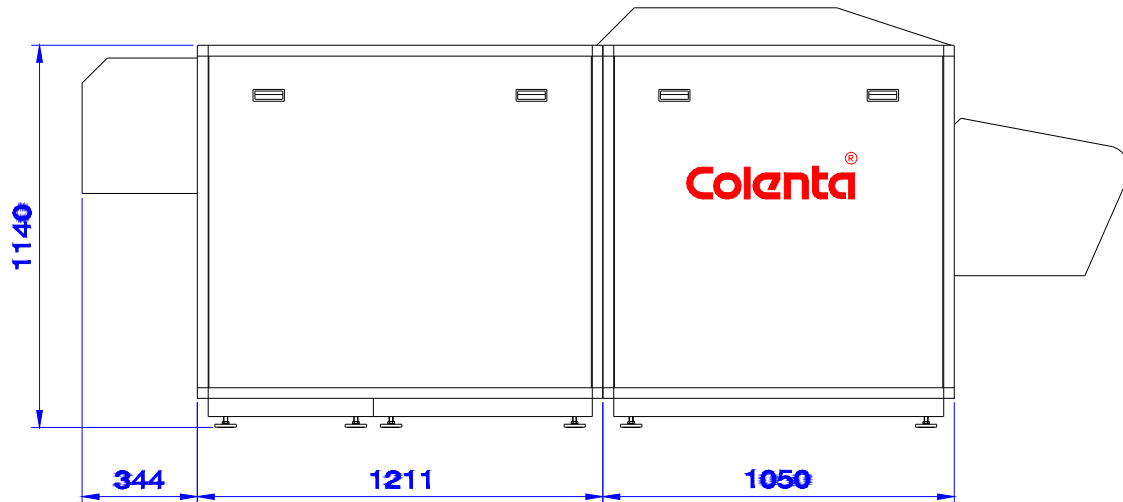

We recommend a minimum walking space of 60cm around the processor.

Specifications for wall-opening if the processor has to be installed that way:

200 RA 80 / 125 5Tank WASH

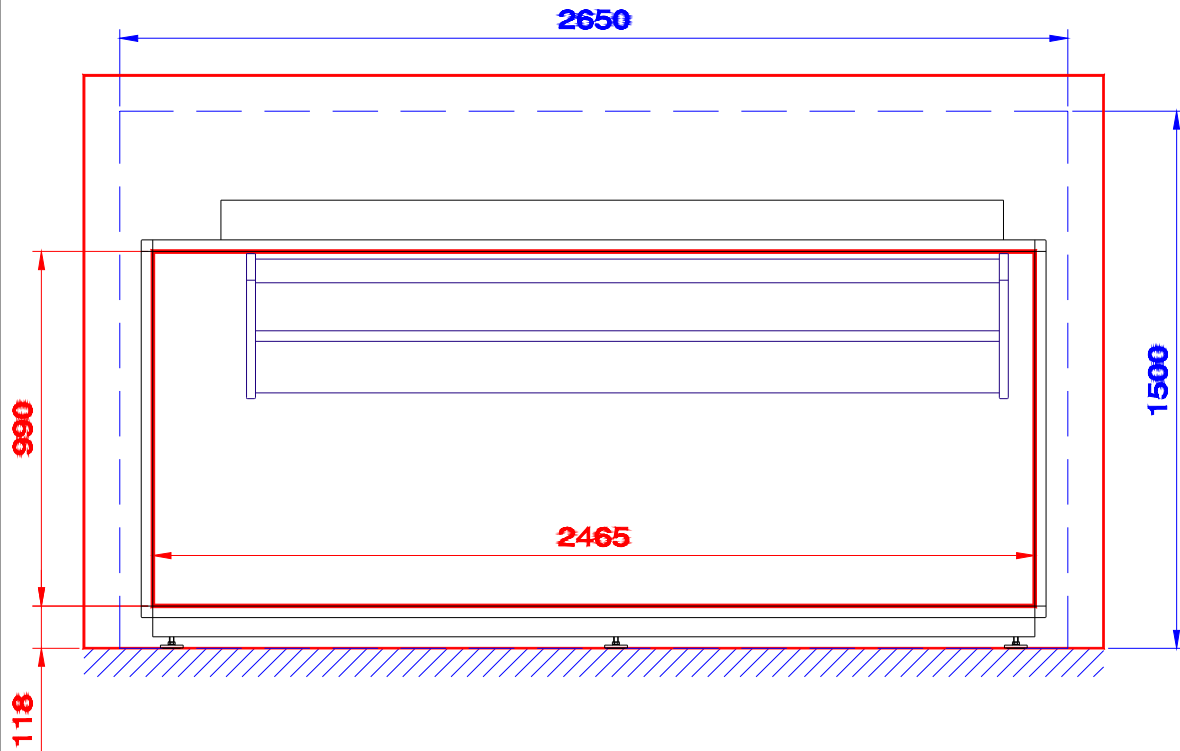

In case the thickness of the wall is more than 2cm, a panel has to be installed this to keep the cover lid of the processor in position - as shown below:

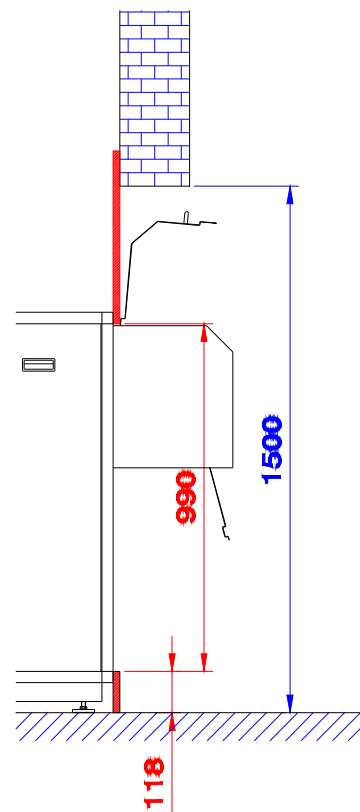

Electrical supply:

Standard, when 3N~400/230V,
50/60 Hz supply available



Total power consumption:	
200 RA4 80 5Tank WASH.....	19.5 kW
200 RA4 125 5Tank WASH.....	22.0 kW

Standard supply net:
3N-400/230 VAC 56/60Hz

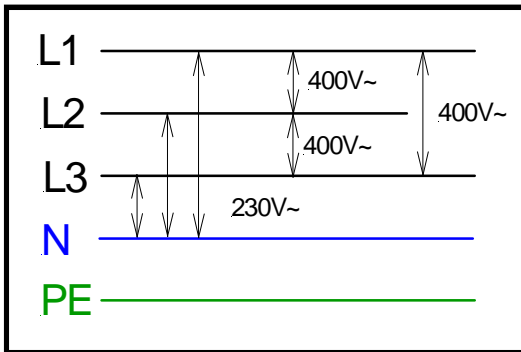

Alternatively:
3x230V 50/60 Hz

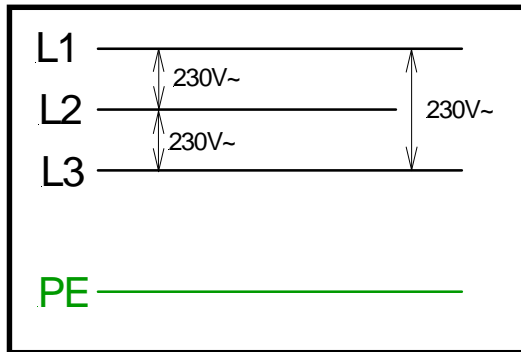

**Single phase connection
(230VAC - 50/60Hz)
is not available for this model!**



cabinet for power connection -
a suitable power cord is
provided with the processor

Details for shipment:



COLENTA 200 RA4 80 5Tank WASH

- 1 Collo - 264x195x140 cm, 840 kg - wet section
- 2 Collo - 265x121x140 cm, 500 kg - dryer Section
- 3 Collo - 228x182x115 cm, 640 kg - rest

COLENTA 200 RA4 125 5Tank WASH

- 1 Collo - 264x195x140 cm, 950 kg - wet section
- 2 Collo - 265x121x140 cm, 500 kg - dryer Section
- 3 Collo - 228x182x115 cm, 730 kg - rest



racks, dryer and
accessories

Colenta 200 RA4 80 / 125 5Tank WASH

Colenta® *Wide Track RA4 Paper Processor - optional accessories :*



Colenta®
Water Supply Panel assy
(see extra documentation)



Colenta®
2x40L / 2x80L Mixing Concole
(see extra documentation)



Colenta®
200 roll feed assy



Colenta®
200 motorized roll take up assy

water panel

processor

chemical
mixing concole

